

(19) World Intellectual Property Organization  
International Bureau



(43) International Publication Date  
29 August 2002 (29.08.2002)

PCT

(10) International Publication Number  
WO 02/067190 A2

(51) International Patent Classification<sup>7</sup>: G06K 19/00

(74) Agent: REISTER, Andrea, G.; Covington & Burling, 1201 Pennsylvania Avenue, N.W., Washington, DC 20004-2401 (US).

(21) International Application Number: PCT/US02/01284

(22) International Filing Date: 18 January 2002 (18.01.2002)

(81) Designated States (national): AE, AG, AL, AM, AT, AU, AZ, BA, BB, BG, BR, BY, BZ, CA, CH, CN, CO, CR, CU, CZ, DE, DK, DM, DZ, EC, EE, ES, FI, GB, GD, GE, GH, GM, HR, HU, ID, IL, IN, IS, JP, KE, KG, KP, KR, KZ, LC, LK, LR, LS, LT, LU, LV, MA, MD, MG, MK, MN, MW, MX, MZ, NO, NZ, OM, PH, PL, PT, RO, RU, SD, SE, SG, SI, SK, SL, TJ, TM, TN, TR, TT, TZ, UA, UG, UZ, VN, YU, ZA, ZM, ZW.

(25) Filing Language: English

(26) Publication Language: English

(30) Priority Data:  
60/263,756 25 January 2001 (25.01.2001) US  
09/988,151 19 November 2001 (19.11.2001) US

(84) Designated States (regional): ARIPO patent (GH, GM, KE, LS, MW, MZ, SD, SL, SZ, TZ, UG, ZM, ZW), Eurasian patent (AM, AZ, BY, KG, KZ, MD, RU, TJ, TM), European patent (AT, BE, CH, CY, DE, DK, ES, FI, FR, GB, GR, IE, IT, LU, MC, NL, PT, SE, TR), OAPI patent (BF, BJ, CF, CG, CI, CM, GA, GN, GQ, GW, ML, MR, NE, SN, TD, TG).

(71) Applicant: BANK OF AMERICA CORPORATION [US/US]; NC1-002-29-01, 101 South Tryon Street, Charlotte, NC 28255 (US).

(72) Inventors: PENTZ, Jamily; 4114 Marquesas Avenue, Tega Cay, SC 29708 (US). BURNS, Emmet; 201 N. Tryon Street, Charlotte, NC 28255 (US). COLLINS, Richard, J.; 148 Whistler Road, Highland Park, IL 60035 (US). MONTGOMERY, R., Bruce; 10207 Wildbracken Court, Charlotte, NC 28210 (US). KENDLE, A., Allen; 2400 Valencia Terrace, Charlotte, NC 28210 (US).

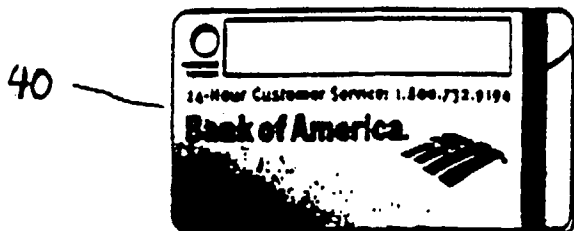
Published:  
— without international search report and to be republished upon receipt of that report

For two-letter codes and other abbreviations, refer to the "Guidance Notes on Codes and Abbreviations" appearing at the beginning of each regular issue of the PCT Gazette.



(54) Title: MINIATURE DATA CARD

WO 02/067190 A2



(57) Abstract: A data card is reduced in size from the conventional standard size credit card. Accessibility of the card is enhanced because the card may be stored in a separate location from conventionally sized cards, such as on a key-chain or similar device. The card of the present invention has a means for storing information, such as a magnetic stripe or computer chip.

## MINIATURE DATA CARD

### BACKGROUND OF THE INVENTION

This invention relates generally to data cards, such as credit cards, that contain a magnetic stripe or other means of storing information. More particularly, this invention relates to such cards that are small in size.

Cards of various kinds have become ubiquitous in modern society. People often carry a number of cards in their wallet or carrying case, including credit cards, ATM or bank cards, debit cards, "smart cards," insurance cards, a driver's license, identification cards, telephone calling cards, transit cards, library cards, and card-entry hotel keys. An increasing number of consumer transactions require use of these cards, for example, as the form of payment, or as identification necessary for another form of payment or admission. Quick and accurate access to certain individual cards is useful and desirable for both the consumer and the vendor of goods or services.

Typically, consumers store credit cards and other types of cards in a wallet or carrying case. These wallets and carrying cases are frequently equipped with sleeves or slots for holding one or more cards in an arrangement selected by the user. Because of the proliferation of the types and numbers of cards carried by consumers, cards are often held very tightly within these sleeves or slots, making retrieval of a particular card difficult. Difficulty in removing a single selected card increases the time necessary for the transaction, causes stored cards to be frequently reshuffled and potentially disorganized, and increases the likelihood that cards will be dropped or lost.

While the number of cards typically carried by consumers is increasing, most consumers use certain types of cards much more frequently than others. For example, some consumers may use a credit card for nearly every sales transaction, but only rarely, if ever, use calling cards, library cards, or insurance cards. Because a subset of the total number of cards carried by consumers must be accessed repeatedly, it is particularly desirable to improve the accessibility of these types of cards.

One way to improve accessibility of frequently used cards is by allowing them to be stored in a separate location from the traditional wallet or carrying case. Such cards could be stored on key-chains, lanyards, hooks, or other similar devices that are easily retrieved from a

bag or pocket. Thus, when a consumer needs to use the card during a transaction, the card may be quickly retrieved and given to the merchant. This provides an added level of convenience to the consumer by making the payment process quicker and simpler. Additionally, the merchant is able to move customers through the line more quickly, improving customer satisfaction. An additional benefit of storing frequently used cards on a key-chain or like device is that the possibility that the card will be lost is decreased. This is because a single card is much more easily misplaced than a card attached to a key-chain.

Conventionally sized cards, however, are too large and cumbersome to be conveniently stored on a key-chain or like device. The individual items on a key chain must be small and compact so that the key-chain can accommodate numerous items. Further, key-chains and the like are often placed in the pockets of clothing, which may be small. Finally, larger items, such as conventional credit cards, could be bent or otherwise damaged when stored on a device such as a key-chain. Thus, for a card to be effectively carried on a key-chain, its size must be significantly reduced.

The degree to which conventional cards may be reduced in size, however, is limited by the requirements of standard magnetic stripe card readers, such as point-of-sale ("POS") terminals through which the user "swipes" the card to make a purchase or payment. In order to ensure interoperability between the magnetic stripe readers and cards bearing magnetic stripes, the parameters defining the magnetic stripe are governed by the International Organization for Standardization (ISO) and the International Electrotechnical Commission (IEC). ISO/IEC 7811 provides standards for the physical characteristics of the magnetic stripe including the location of the stripe on the card, the surface profile of the stripe, and the height of the stripe above the card surface. It would be advantageous for a reduced-size card to comply with ISO/IEC 7811, or otherwise be compatible with existing card readers and POS terminals.

Proper functioning of the magnetic stripe is very important. On conventional cards, such as credit cards, magnetic stripes contain encoded information that electronic readers can read to perform a function or confirm identification. For example, on credit and debit cards, the magnetic stripe is usually encoded with specific account information such as the credit card number, cardholder's name, the card expiration date, and a personal identification code. If the electronic device for reading the encoded information cannot properly read the magnetic stripe, the vendor must enter the information manually, using a keypad, telephone, or other similar

device. Manually entering the encoded information adds both indirect and direct costs to the vendor. For example, the additional time necessary to enter the information manually may increase needs for register operators and decrease the vendor's ability to attend to other customer matters. In addition, vendors are frequently charged increased transaction fees by the card issuer for a manually entered transaction.

Thus, a need exists for providing cards, such as credit cards, that are reduced in size from currently used cards, and yet still are operable with currently used readers. Such a card would greatly enhance the efficiency of frequent transactions, including sales transactions, by allowing regularly used cards to be readily and easily retrieved. Further, because such a card could be readily stored on a key-chain or like device, the probability that the card would be lost or misplaced is reduced. Finally, because such a card would be compatible with currently used readers, no redesign of existing card reader technology would be required.

#### BRIEF SUMMARY OF THE INVENTION

In one aspect, the present invention provides a data card that is reduced in size from conventional credit-card-sized cards, and contains an information storage medium, such as a magnetic stripe or a computer chip, that can be read by existing card reader technology.

In another aspect, a reduced-size data card is provided with a magnetic stripe, which is located near an edge of the card, on which data is encoded. Such a magnetic stripe is reduced in size from the magnetic stripes found on conventionally sized cards, and contains data encoded at a higher bit density than on conventionally sized cards. The magnetic stripe is compatible with existing card reader technology.

In yet another aspect, a reduced-size data card is provided with a hole to allow key-chain storage, and the core may be composed, at least in part, of polyester. Additionally, the surface of a data card of the present invention may also be provided with raised dimples or craters to enhance gripability of the card. Further, information may be printed on the surface of the card, in order to reduce or eliminate the need to emboss the card with raised lettering or embossing.

In still another aspect, a reduced-size data card of the present invention may have an angled edge.

## BRIEF DESCRIPTION OF THE DRAWINGS

FIG. 1A is an illustration of the front view of a conventional credit card.

FIG. 1B is an illustration of the back view of a conventional credit card.

FIG. 2A is an illustration of the front view of one preferred embodiment of the reduced-size data card of the present invention.

FIG. 2B is an illustration of the back view of the embodiment shown in FIG. 2A.

FIG. 3A is an illustration of the front view of another preferred embodiment of the reduced-size data card of the present invention.

FIG. 3B is an illustration of the back view of the embodiment shown in FIG. 3A.

FIG. 4A is an illustration of the front view of another preferred embodiment of the reduced-size data card of the present invention.

FIG. 4B is an illustration of the front view of another preferred embodiment of the reduced-size data card of the present invention.

FIG. 4C is an illustration of the back view of the embodiment shown in FIG. 4A.

FIG. 4D is an illustration of an alternate back view of the embodiment shown in FIG. 4A.

FIG. 5A is an illustration of the front view of another preferred embodiment of the reduced-size data card of the present invention.

FIG. 5B is an illustration of the back view of the embodiment shown in FIG. 5A.

FIG. 6A is an illustration of the front view of another preferred embodiment of the reduced-size data card of the present invention.

FIG. 6B is an illustration of the back view of the embodiment shown in FIG. 6A.

FIG. 7A is an illustration of the front view of another preferred embodiment of the reduced-size data card of the present invention

FIG. 7B is an illustration of the front view of another preferred embodiment of the reduced-size data card of the present invention

FIG. 7C is an illustration of the front view of another preferred embodiment of the reduced-size data card of the present invention

FIG. 8A is a partial sectional view of another preferred embodiment of the reduced-size data card of the present invention taken through the tread where the tread includes raised dimples.

FIG. 8B is a partial sectional view of another preferred embodiment of the reduced-size data card of the present invention taken through the tread where the tread includes craters.

FIG. 9A is an illustration of the front view of another preferred embodiment of the reduced-size data card of the present invention.

FIG. 9B is an illustration of the back view of the embodiment shown in FIG. 9A.

FIG. 9C is an illustration of a side view of the embodiment shown in FIG. 9A.

FIG. 10 is an illustration of the ISO/IEC 7811 standards for location and width of magnetic stripe data tracks 1 and 2.

FIG. 11 is an illustration of the ISO/IEC 7811 standards for location and width of magnetic stripe data track 3.

FIG. 12 is an illustration of the ISO/IEC 7811 standards for magnetic stripe location and size.

FIG. 13A is an illustration of the front view of another preferred embodiment of the reduced-size data card of the present invention.

FIG. 13B is an illustration of the back view of the embodiment shown in FIG. 13A.

#### DETAILED DESCRIPTION OF THE INVENTION

Reference will now be made to the present preferred embodiments of the invention, examples of which are illustrated in the accompanying drawings.

FIGs. 1A-B illustrate one embodiment of a conventional credit card. FIG. 1A shows the front side of a conventional standard size credit card 10, which is typically embossed using raised lettering with a credit card number 11, an expiration date 12, and the name of the card-holder 13. Such a card also usually contains the name of the issuing bank 14, and the credit card company, such as American Express®, MasterCard®, or VISA®, 15. It may also contain other information, such as sponsor logos and/or a “platinum” or similar indication. Additionally, the credit card may contain an identification photograph of the card-holder for security purposes. The back side of conventional card 10, shown in FIG. 1B, typically contains a box 16 that can be signed by the card holder, which is used for verification purposes when a purchase is made. Additionally, the back side of card 10 contains a magnetic stripe 17, which runs parallel to the card’s largest dimension. Magnetic stripe 17 stores information, such as credit card number, that can be read by conventional point of sale (“POS”) terminals. A standard credit card is approximately 3 3/8 in. long by 2 1/4 in. high, for an aspect ratio (length/height) of approximately 1.5, and has a thickness of approximately 0.75 mm.

The card of the present invention includes an information storage medium. By “information storage medium,” is meant a medium that is added to the card that stores information in a magnetic, electronic, or electro-magnetic manner. This term does not include printed information either affixed to or printed directly on the card. Exemplary information storage media suitable for use with the present invention include, but are not limited to, magnetic stripes and computer chips.

FIGs. 2A-B depict a preferred embodiment of the present invention, including a generally rectangular card 20, a magnetic stripe 21, and a hole 22. The dimensions of card 20 are approximately 2 1/8 in. long by 1 1/4 in. high, for an aspect ratio (length/height) of approximately 1.7, and a thickness of approximately 0.75 mm. This is a significant reduction from the dimensions of a standard credit card. As would be appreciated by one skilled in the art, the foregoing specific dimensions are representative only, and the present invention is not limited to any particular dimensions. Preferably, the present invention is carried out using cards with dimensions ranging in length from approximately 1 in. to 3 in., and ranging in height from approximately 1 in. to 1 7/8 in. Thus, the aspect ratio (length/height) could range from approximately 0.53 (1 / 1.875) to 3 (3 / 1).

Magnetic stripe 21 is located on the back side of card 20, as shown in FIG. 2B, and is oriented perpendicularly to the card's largest dimension. Alternatively, the magnetic stripe could be located on the front side of card 20. In one embodiment of the present invention, magnetic stripe 21 is approximately 0.41 in. in width. In another embodiment, shown for example in FIGs. 3A-B, magnetic stripe 31 is approximately 0.25 in. in width.

ISO/IEC 7811 provides standards for the location of the stripe on the card, the surface profile of the stripe, and the height of the stripe above the card surface. Generally, designers of cards attempt to comply with these standards to ensure compatibility with existing POS terminals. Unexpectedly, the card of the present invention is compatible with existing point of sale terminals without complying with several aspects of the ISO/IEC standards, as explained in more detail below.

Finally, hole 22 is shown as located in a corner of card 20, and allows the card to be readily carried on a key-chain or like device. It should be apparent to one skilled in the art that hole 20 can be located anywhere on the card that allows the card to be carried by a key-chain or similar device and does not interfere with the magnetic stripe.

FIGs. 3A-B show an alternate preferred embodiment. Like the previous embodiment, this embodiment includes a generally rectangular card 30, a magnetic stripe 31, that is oriented perpendicularly to the card's largest dimension, and a hole 32. Here, however, magnetic stripe 31 is narrower in width than magnetic stripe 21 of FIG. 2B. A narrower magnetic stripe may be utilized when less information is needed to be stored by the magnetic stripe or when encoding techniques allow more information to be stored in a reduced space.

FIGs. 4A-D show alternate preferred embodiments. FIG. 4A shows a generally rectangular shaped card 40 with a hole 42. Card dimensions (2 1/8 in. by 1 1/4 in.) are shown on FIG. 4A and are significantly reduced from the standard size credit card. Additionally, card 40 contains an identification photograph 43, various logos 44 and 45, and additional information 46. Further, embossed information, such as credit card number or expiration date (not shown) could be included. Other arrangements of logos, and information should be apparent to one of ordinary skill in the art from this description or from practice. For example, FIG. 4B shows card 40', which is similar to card 40 (FIG. 4A) but without the identification photograph, and with a different arrangement of logos and other information.



FIG. 4C shows the back side of card 40, depicted in FIG. 4A, which includes magnetic stripe 41 oriented perpendicularly to the card's largest dimension. Additionally, FIG. 4C includes signature block 47. Signature block 47 is to be signed by the card holder, and is used for signature verification when a purchase is made. Finally, the back side of card 40 may contain logos 48 and other information, as would be apparent to one of ordinary skill in the art.

FIG. 4D shows an alternate arrangement of the back side of card 40. It shows magnetic stripe 41' which is narrower than magnetic stripe 41 of FIG. 4C. Narrower magnetic stripes may be utilized when less information is required to be stored by the magnetic stripe, or when encoding techniques allow more information to be stored in less space.

FIGs. 5A-B show an alternate preferred embodiment, including a generally rectangular shaped card 50 and a magnetic stripe 51, oriented perpendicularly to the card's largest dimension. Unlike previous embodiments, the present embodiment does not contain a hole. While a hole is a helpful way to attach a card of the present invention to a key-chain or like device, such a hole is not required. Thus, the card can be attached to the key-chain by a clip or similar device. Additionally, the card of the present invention is not required to be stored on a key-chain or like device and could be stored in any fashion chosen by the consumer, such as directly in the consumer's pocket or bag. It should be readily apparent to one skilled in the art that any of the embodiments described herein could be modified such that the hole is removed.

FIGs. 6A-B show still another alternate preferred embodiment, including a generally rectangular shaped card 60, a magnetic stripe 61, and a hole 62. Magnetic stripe 61 is oriented parallel to the card's largest dimension. As described above, magnetic stripe 61 is preferably compatible with existing magnetic stripe readers. Magnetic stripe 61 may be either narrow or wide, depending on the amount of data required to be stored and the degree of data compression. Because magnetic stripe 61 is oriented parallel to the card's longest dimension, it may be capable of storing a greater amount of information at a given width than magnetic stripe 21 of FIG. 2B which is oriented perpendicularly to the card's largest dimension. Thus, the present embodiment may be more easily implemented when greater amounts of information storage is required. It should be readily apparent to one of ordinary skill in the art that any of the embodiments described herein could be modified such that the magnetic stripe is oriented parallel to the card's largest dimension.

Conventional credit cards and the like have been generally rectangular in shape. However, the card of the present invention may take on other shapes. For example, the card could be any number of geometric shapes such as triangular or trapezoidal. Additionally, the card could take on the shape of naturally occurring or human-made objects, such as pine trees or airplanes. Such shapes could be related to the card issuer or sponsor. Thus, a credit card that a consumer can use to accrue frequent flier miles could be in the shape of an airplane. The dimensions of such cards generally comport with the size guidelines suggested herein. Because such cards are not rectangular, the magnetic stripe would not necessarily be oriented as described above (either parallel to or perpendicular to the card's largest dimension). Thus, the magnetic stripe could be oriented in any number of ways, depending on the shape of the card.

Additionally, any of the embodiments described herein could be provided with a tread to increase the gripability of the card. Such treads are described in detail in U.S. Patent Application No. 09/611,320 filed on July 6, 2000, the entirety of which is hereby incorporated by reference.

These treads could take the form of a plurality raised dimples disposed on a surface of the card. The treads are preferably disposed on the surface or face of the card that comes into contact with the user to increase gripability. FIGs. 7A-C show three alternate preferred embodiments of the present invention in which the surface of the card is provided with treads. In each a number of dimples 77 is arranged to form a plurality of treads 76 on the front face 71 of card 70. In FIG. 7A, the dimples 77 are arranged to form treads 76 in either a triangular pattern or a line. The dimples 77, however, can also be arranged in any number of patterns. As depicted in FIGs. 7A-7C, the treads 76 are located near an edge 73 of card 70, and in each preferred embodiment depicted in FIGs. 7A-7C, a tread 76 is located near the top edge 72 of the card 70. Other arrangements of dimples 77 forming treads 76 should be apparent to one of skill in the art from this description of from practice of the invention depending on the intended or experienced use of the card.

FIG. 8A shows a sectional view of a preferred embodiment of card 70 of the present invention taken along the line X-X of FIG. 7A, in which the dimples 77 are raised from the front face 71 of the card 70. In such an embodiment, the height of each dimple should be selected so as not to interfere with the proper operation of POS terminals or other devices that require the card to be swiped by or through the device.

FIG. 8B shows a sectional view of an alternate preferred embodiment of card 70 of the present invention. In this embodiment, the dimples are created in such a manner as to create individual craters 77 in which the lip of the crater is raised slightly above the front surface 71 of the card 70, while the center of the crater is slightly below the surface of the card.

While the specific embodiments described herein are cards having magnetic stripes such as credit cards, debit cards, and bank cards, this is by way of example, and the invention is not limited to these types of cards. Thus, the present invention can be implemented for many different types of data cards including Smart Cards (i.e. cards containing computer chips that store information), stored value cards, proximity chip cards, and other cards that are capable of storing information. A detailed discussion of data cards containing embedded computer chips may be found in U.S. Patent No. 4,443,027 to McNeely et al., the entirety of which is hereby incorporated by reference.

Another preferred embodiment of the present invention will now be described in greater detail. This preferred embodiment, shown in FIGs. 9A-C, includes a generally rectangular card 90, a magnetic stripe 91, and a hole 92. The front face 93 of card 90 is shown in FIG. 9A; the rear face 94 of card 90 is shown in FIG. 9B. Approximate dimensions of card 90, as indicated on FIG. 9B, are  $1 \frac{9}{16}$  inches (height) by  $2 \frac{9}{16}$  inches (length). The width of the card, shown in FIG. 9C (not to scale), is approximately 0.75 mm. These height and length dimensions are reduced from conventionally-sized credit card dimensions, which are approximately  $2 \frac{1}{4}$  inches (height) by  $3 \frac{3}{8}$  inches (length).

Once again, the specific dimensions of card 90 are representative only, and the present invention is not limited to any particular dimensions. Nevertheless, the present invention is preferably carried out using cards with dimensions ranging from approximately 1 inch by 1 inch to approximately  $1 \frac{7}{8}$  inches to 3 inches.

The front face 93 of card 90 contains various information such as card number 95, expiration date 96, and card-holder name 97. This information may be embossed on the card. In a preferred embodiment, the card is free from or devoid of embossing or other raised lettering. In such an embodiment, the information may be printed on the card using laser printing techniques, as are known in the art.

Between front and rear faces 93 and 94 of card 90 is a core 99, as shown in FIG. 9C. This core may be composed of, at least in part, polyester. In one embodiment, the core is composed of 80% polyester and 20% polyvinyl chloride (PVC). The use of polyester in the core is advantageous because it increases the durability of the card. As would be apparent to one skilled in the art, various percentages of polyester and other materials may be used for the card core.

In the embodiment shown in FIGs. 9A-C, magnetic stripe 91 is positioned parallel to the bottom edge 98 of card 90. The bottom edge, of course, is defined with respect to the particular card orientation shown in FIG. 9B. As would be readily apparent to one skilled in the art, rotation of card 90 could cause "bottom" edge 98 to appear as if it is a right, left, or top edge. Magnetic stripe 91 is used to store encoded data such as the name of the card-holder, a credit card or other account number, card expiration date, and a personal identification code or other security information. The lengthwise dimension of magnetic stripe 91 is approximately 2 9/16 inches. As defined herein, the lengthwise dimension of a magnetic stripe is the largest dimension of the magnetic stripe. However, as described above, the present invention is not limited to any particular dimensions. Preferably, the lengthwise dimension of the magnetic stripe ranges from approximately 1 inch to approximately 3 inches.

The requirements of ISO/IEC 7811, which specifies the international standards for magnetic stripes will now be discussed, and then compared to the characteristics of magnetic stripe 91 of the present invention. Designers of cards bearing magnetic stripes attempt to comply with the standards set forth in ISO/IEC 7811 in order to ensure compatibility and interoperability with current magnetic stripe readers and POS terminals.

ISO/IEC 7811 specifies that a magnetic stripe may contain up to three tracks of encoded information. As will be appreciated by one skilled in the art, each track is essentially a strip of specified width and location running the length of the magnetic stripe, on which data is encoded. According to ISO/IEC 7811, track 1 is located closest to the edge of the card and contains data encoded at 210 bits per inch (bpi). Track 2 is adjacent to track 1 and contains data encoded at 75 bpi. FIG. 10 shows the width and location of tracks 1 and 2 as specified by ISO/IEC 7811-4, the entirety of which is hereby incorporated by reference. Track 3 is the furthest from the edge of the card and contains data encoded at 210 bpi. FIG. 11 shows the

width and location of track 3 as specified by ISO/IEC 7811-5, the entirety of which is hereby incorporated by reference.

In all cases, data is encoded on the tracks using two-frequency encoding, as specified in ISO/IEC 7811. As will be understood by one skilled in the art, two-frequency encoding involves the use of flux transitions to encode data. The encoding comprises data and clocking transitions together. The presence of a flux transition between clocking transitions signifies that the bit is a "one;" the absence of a flux transition signifies a "zero." Additional detailed discussion of two-frequency encoding may be found in ISO/IEC 7811-2 and 7811-6, the entirety of which is incorporated herein by reference.

Each track of data contains a "start sentinel." The start sentinel is the first data bit, and indicates the beginning of the encoded data on each track. As shown in FIG. 12, ISO/IEC 7811 specifies that the location of the start sentinel is approximately 0.293 inches from the right side of the card for all tracks.

FIG. 12 shows additional physical characteristics for magnetic stripes, as specified by ISO/IEC 7811. The minimum length of the magnetic stripe is specified as 3.135 inches (3.250 inches minimum from the right edge of the card to the left edge of the stripe minus the 0.115 inches maximum from the right edge of the card to the right edge of the stripe). The minimum width of the magnetic stripe is 0.25 inches for cards using tracks 1 and 2, and 0.41 inches for cards using all three tracks.

Magnetic stripe 91 (FIG. 9B) is different in several respects from the magnetic stripes specified by ISO/IEC 7811. First, the length of magnetic stripe 91 is approximately 2 9/16 inches, significantly shorter than the 3.135 inch minimum length specified by ISO/IEC 7811.

Second, the data on magnetic stripe 91 is encoded at bit densities higher than those prescribed in ISO/IEC 7811. Magnetic stripe 91 contains data encoded on tracks 1 and 2. In order to ensure that sufficient data is encoded in the smaller magnetic stripe area, data is encoded on track 1 at 260 bpi and on track 2 at 100 bpi. Both of these bit densities are significantly higher than those specified in ISO/IEC 7811 for tracks 1 and 2 (210 bpi and 75 bpi, respectively). As should be appreciated by one skilled in the art, data could also be encoded on track 3 if necessary or desirable in a particular circumstance. It should also be noted that the

present invention is not limited by these specific bit densities, and other bit densities could be selected that ensure the storage of the appropriate amount of information in the available space.

Also, as shown in FIG. 9B, the start sentinel of magnetic stripe 91 is located 0.200 inches from the right edge of card 90. This start sentinel location is significantly different from that specified in ISO/IEC 7811, which specifies that the start sentinel must be located 0.293 inches from the right edge of the card.

Preferably, the data on tracks 1 and 2 of magnetic stripe 91 is encoded using standard two-frequency encoding. However, it should be understood by one skilled in the art that the present invention is not limited to a particular encoding technique. Preferably, the width of each track and the distance of each track from the bottom edge 98 of card 90 complies with the requirements of ISO/IEC 7811, as described above and shown in FIG. 10.

The dimensions of card 90 itself are different from the dimensions specified in ISO/IEC 7810, the entirety of which is hereby incorporated by reference, which generally specifies physical parameters of identification cards. Notably, ISO/IEC 7810 establishes minimum dimensions for identification cards at 2.125 inches by 3.370 inches. The dimensions of card 90 are approximately 1 9/16 inches by 2 9/16 inches.

Given that card 90 of the present invention does not comply with numerous standards and specifications set forth in ISO/IEC 7810 and 7811, it would be expected by those skilled in the art that the card would not be operable with standard magnetic stripe readers and POS terminals. However, tests performed on prototype cards indicate that the data cards of the present invention are compatible with standard equipment.

In order to test the prototype cards, twenty-five cards, substantially similar to that shown in FIGs. 9A and 9B and described above, were assembled and encoded with twenty-five different accounts. These twenty-five cards were then tested using five different POS terminals. The five POS terminals were standard merchant POS terminals manufactured by VeriFone Inc. A number of the twenty-five cards were tested on each of the five POS terminals. In order to ensure proper reading of the card, two tests were performed. First, after swiping each test card through the terminal, the terminal attempted to print a receipt showing, among other things, the name associated with the account encoded on each card. Second, the terminal used the data obtained from the card, and attempted to access the interchange system and obtain authorization

for a transaction. All tested cards passed both tests. This testing indicates that the data card of the present invention is unexpectedly compatible with POS terminals, despite the non-compliance with numerous aspects of ISO/IEC 7810 and 7811.

Additional testing was carried out using cards similar to card 130, shown in FIGs. 13A and 13B. Card 130 differs from card 90 only in that edge 139 of card 130 is angled. The same testing protocol described above was performed on twenty-five cards substantially similar to card 130 as shown in FIGs. 13A and B. The magnetic stripe 131 on card 130 is substantially the same as magnetic stripe 91 of card 90 (FIG. 9B). All cards tested passed both the receipt and authorization tests.

Thus, testing the prototype cards of various embodiments reveals that cards of the present invention are interoperable with magnetic card reader technology and POS terminals despite non-compliance with several of the relevant ISO/IEC standards.

Now will be described a method of use for a reduced-size data card of the present invention. As described above, such a card may be stored on a key-chain, lanyard, hook or similar device. Alternatively, the card may simply be placed in the pocket or bag of a consumer. When a consumer carrying a card of the present invention approaches a POS terminal or other card reader, such as when making sales transaction, the consumer may be required to produce the card to complete the transaction. Because of the convenience of storage, the consumer quickly and easily retrieves the card, and either gives the card to the merchant to "swipe" through the reader, or the consumer may be permitted to "swipe" the card him/herself. The POS terminal or other card reader then "reads" the encoded information on the card, such as card number, credit limit or the like, and the transaction is completed. The card may then be re-stored by the consumer until the next usage.

Although particular embodiments of the invention have been described and illustrated herein, it is recognized that modifications and variations may readily occur to those skilled in the art, and consequently it is intended that the claims be interpreted to cover such modifications and equivalents.

## CLAIMS

1. A data card comprising a first face, a second face, and an information storage medium, wherein said card has dimensions that are less than about 2 1/4 inches by about 3 3/8 inches.
2. A data card as in claim 1, wherein the dimensions of said card are in the range of about 1 inch by about 1 inch to about 1 7/8 inches by about 3 inches.
3. A data card as in claim 1, wherein the information storage medium comprises a magnetic stripe.
4. A data card as in claim 3, wherein the magnetic stripe is positioned parallel to an edge of said card.
5. A data card as in claim 3, wherein the magnetic stripe is positioned perpendicular to a largest dimension of said card.
6. A data card as in claim 3, wherein the magnetic stripe comprises two tracks for storing encoded data.
7. A data card as in claim 6, wherein a first of said two tracks comprises data encoded at greater than about 210 bits per inch.
8. A data card as in claim 7, wherein the first of said two tracks comprises data encoded at about 260 bits per inch.
9. A data card as in claim 6, wherein a second of said two tracks comprises data encoded at greater than about 75 bits per inch.
10. A data card as in claim 9, wherein the second of said two tracks comprises data encoded at about 100 bits per inch.
11. A data card as in claim 6, wherein the encoded data is encoded using two-frequency encoding.



12. A data card as in claim 1, wherein said first and second faces define a hole therethrough.
13. A data card as in claim 1, further comprising a core disposed between said first and second faces, wherein said core comprises polyester.
14. A data card as in claim 13, wherein said core comprises about 80% polyester.
15. A data card as in claim 1, wherein the dimensions of said card are about 1 9/16 inches by about 2 9/16 inches.
16. A data card as in claim 1, wherein said first and second faces are devoid of raised lettering.
17. A data card as in claim 1, further comprising lettering printed on at least one of said first and second faces.
18. A data card as in claim 1, wherein the information storage medium comprises a computer chip.
19. A data card as in claim 1, further comprising a tread comprising a plurality of raised dimples for improving the gripability of said card, wherein said plurality of raised dimples are disposed on one of said first and second faces, said one face coming into contact with a user to improve gripability.
20. A data card as in claim 1, further comprising a plurality of craters disposed on one of said first and second faces, each of said plurality of craters comprising: a lip and a center, and wherein the lip of each crater is raised slightly above said one face, and the center of each crater is indented slightly into said one face.
21. A data card comprising a first face, a second face, and a magnetic stripe, wherein the magnetic stripe is positioned parallel to an edge of said card, and the magnetic stripe has a lengthwise dimension of less than about 3.135 inches.

22. A data card as in claim 21, wherein the lengthwise dimension of the magnetic stripe is in the range of about 1 inch to about 3 inches.
23. A data card as in claim 22, wherein the magnetic stripe comprises two tracks for storing encoded data.
24. A data card as in claim 23, wherein a first of said two tracks comprises data encoded at greater than about 210 bits per inch.
25. A data card as in claim 24, wherein the first of said two tracks comprises data encoded at about 260 bits per inch.
26. A data card as in claim 23, wherein a second of said two tracks comprises data encoded at greater than about 75 bits per inch.
27. A data card as in claim 26, wherein the second of said two tracks comprises data encoded at about 100 bits per inch.
28. A data card as in claim 23, wherein the encoded data is encoded using two-frequency encoding.
29. A data card as in claim 21, further comprising a core disposed between said first and second faces, wherein said core comprises polyester.
30. A data card as in claim 29, wherein the core comprises about 80% polyester.
31. A data card as in claim 21, wherein the lengthwise dimension of the magnetic stripe is about  $2 \frac{9}{16}$  inches.
32. A data card as in claim 21, wherein said first and second faces are devoid of raised lettering.
33. A data card as in claim 21 further comprising lettering printed on at least one of said first and second faces.
34. A data card as in claim 21 further comprising a tread comprising a plurality of raised dimples for improving the gripability of said card;

wherein said plurality of raised dimples are disposed on one of said first and second faces, said one face coming into contact with a user to improve gripability.

35. A data card as in claim 21, further comprising a plurality of craters disposed on one of said first and second faces, each of said plurality of craters comprising: a lip and a center, and wherein the lip of each crater is raised slightly above said one face, and the center of each crater is indented slightly into said one face.

36. A data card as in claim 21, wherein said first and second faces define a hole therethrough.

37. A data card as in claim 21, further comprising an angled edge.

38. A data card comprising a first face, a second face, an angled edge, and an information storage medium, wherein a largest dimension of said card is less than about  $3 \frac{3}{8}$  inches.

39. A data card as in claim 38, wherein the largest dimension of said card is in the range of about  $1 \frac{7}{8}$  inches to about 3 inches.

40. A data card as in claim 38, wherein the information storage medium comprises a magnetic stripe.

41. A data card as in claim 40, wherein the magnetic stripe is positioned parallel to an edge of said card.

42. A data card as in claim 41, wherein the magnetic stripe comprises two tracks for storing encoded data.

43. A data card as in claim 42, wherein a first of said two tracks comprises data encoded at greater than about 210 bits per inch.

44. A data card as in claim 43, wherein the first of said two tracks comprises data encoded at about 260 bits per inch.

45. A data card as in claim 42, wherein a second of said two tracks comprises data encoded at greater than about 75 bits per inch.

46. A data card as in claim 45, wherein the second of said two tracks comprises data encoded at about 100 bits per inch.

47. A data card as in claim 42, wherein the encoded data is encoded using two-frequency encoding.

48. A data card as in claim 38, wherein said first and second faces define a hole therethrough.

49. A data card as in claim 38, further comprising a core disposed between said first and second faces, wherein said core comprises polyester.

50. A data card as in claim 49, wherein said core comprises about 80% polyester.

51. A data card as in claim 38, wherein said first and second faces are devoid of raised lettering.

52. A data card as in claim 38, further comprising lettering printed on at least one of said first and second faces.

53. A data card as in claim 38, wherein the information storage medium comprises a computer chip.

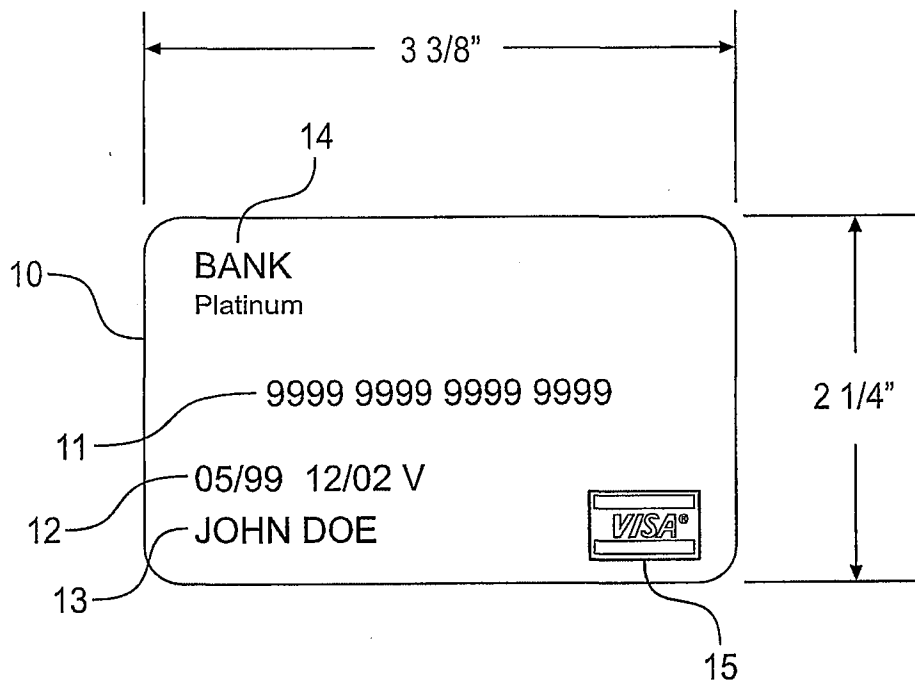
54. A data card as in claim 38, further comprising a tread comprising a plurality of raised dimples for improving the gripability of said card, wherein said plurality of raised dimples are disposed on one of said first and second faces, said one face coming into contact with a user to improve gripability.

55. A data card as in claim 38, further comprising a plurality of craters disposed on one of said first and second faces, each of said plurality of craters comprising: a lip and a center, and wherein the lip of each crater is raised slightly above said one face, and the center of each crater is indented slightly into said one face.

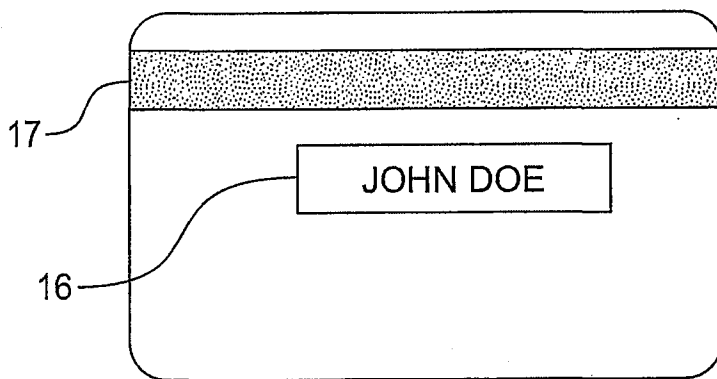
56. A data card as in claim 40, wherein the magnetic stripe is positioned perpendicular to the largest dimension of said card.

57. A data card as in claim 40, wherein the magnetic stripe is positioned parallel to said angled edge.

1/10

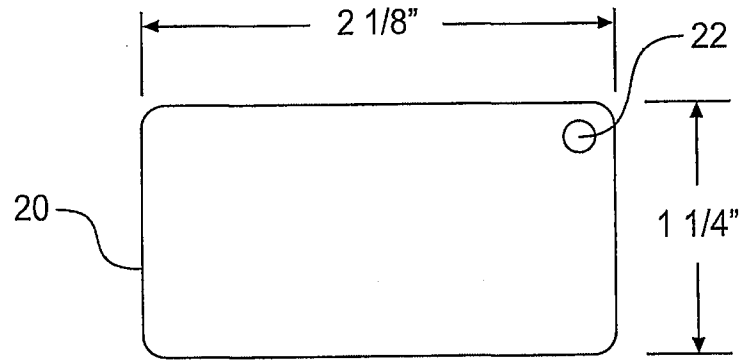


**FIG. 1A**

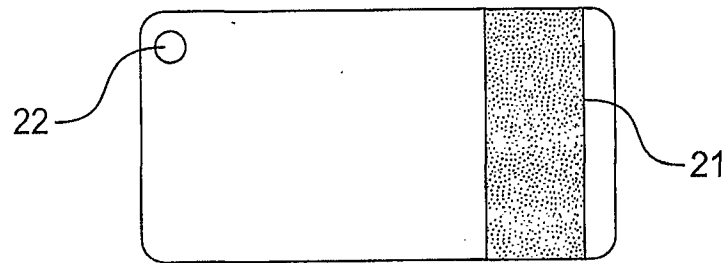


**FIG. 1B**

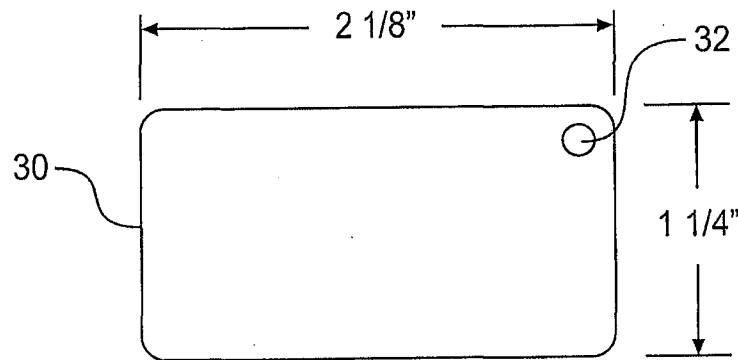
2/10



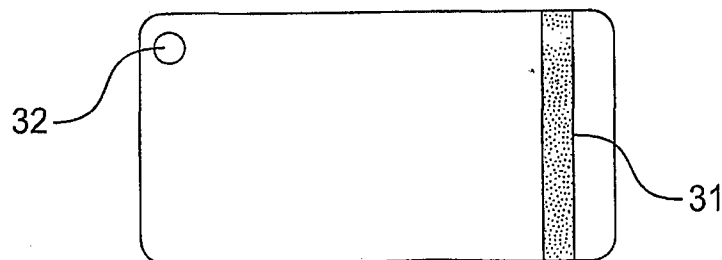
**FIG. 2A**



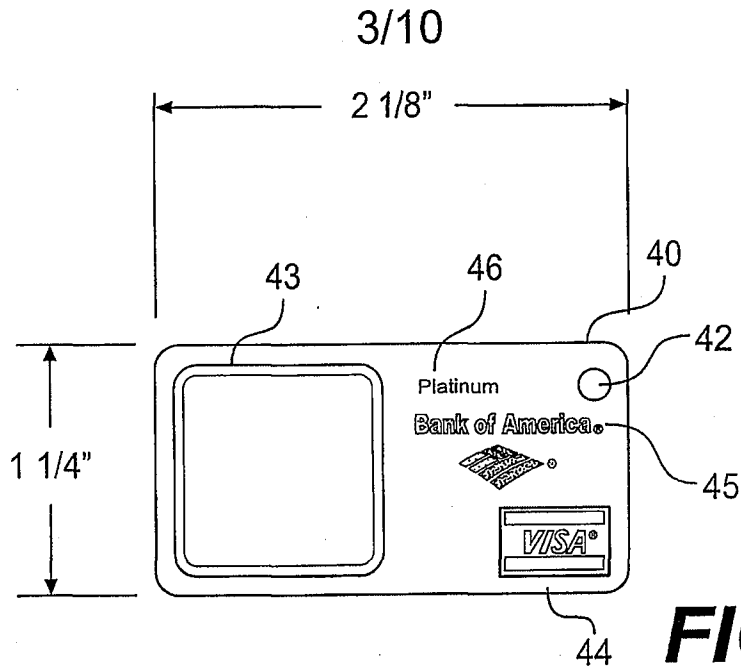
**FIG. 2B**



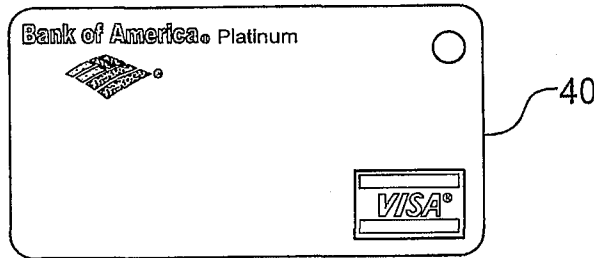
**FIG. 3A**



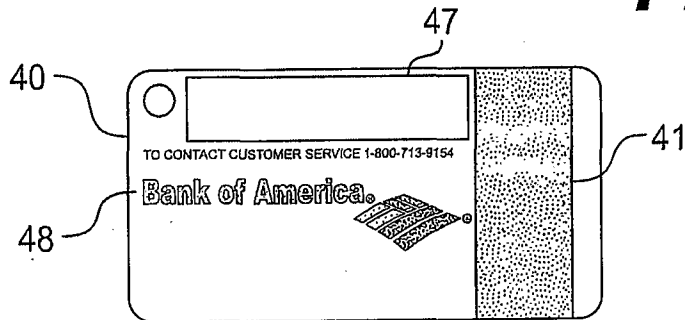
**FIG. 3B**



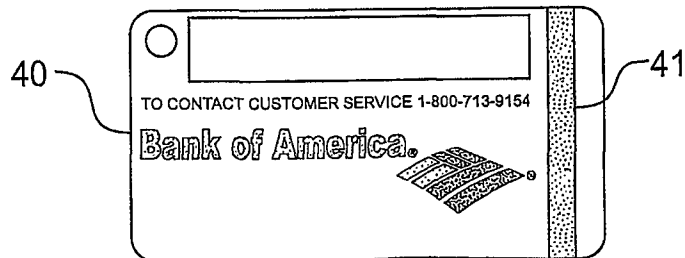
**FIG. 4A**



**FIG. 4B**



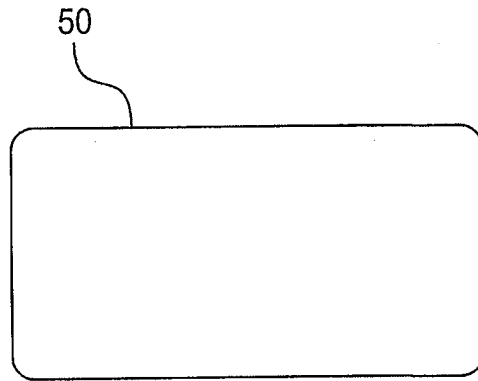
**FIG. 4C**



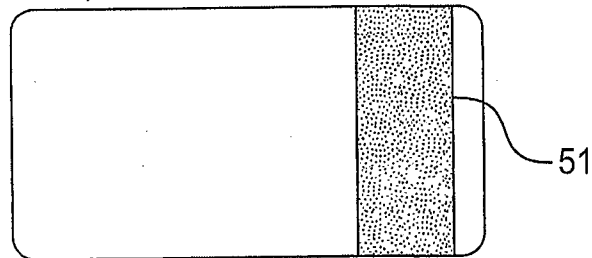
**FIG. 4D**



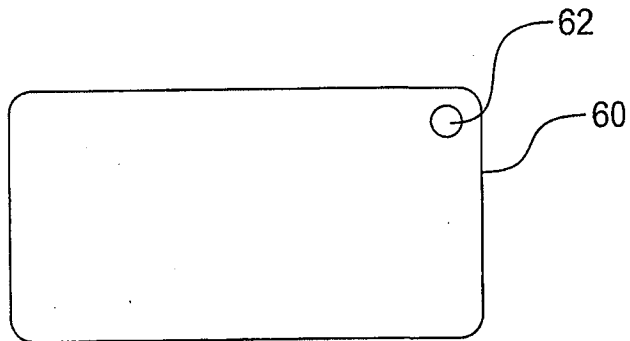
4/10



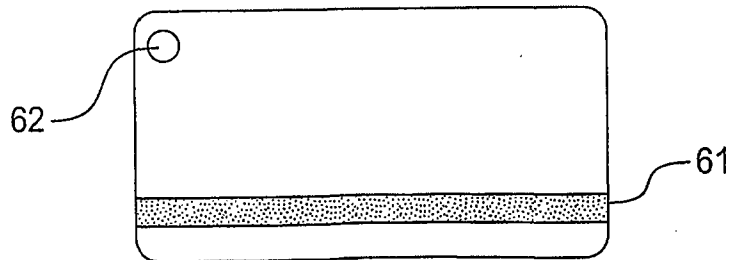
**FIG. 5A**



**FIG. 5B**

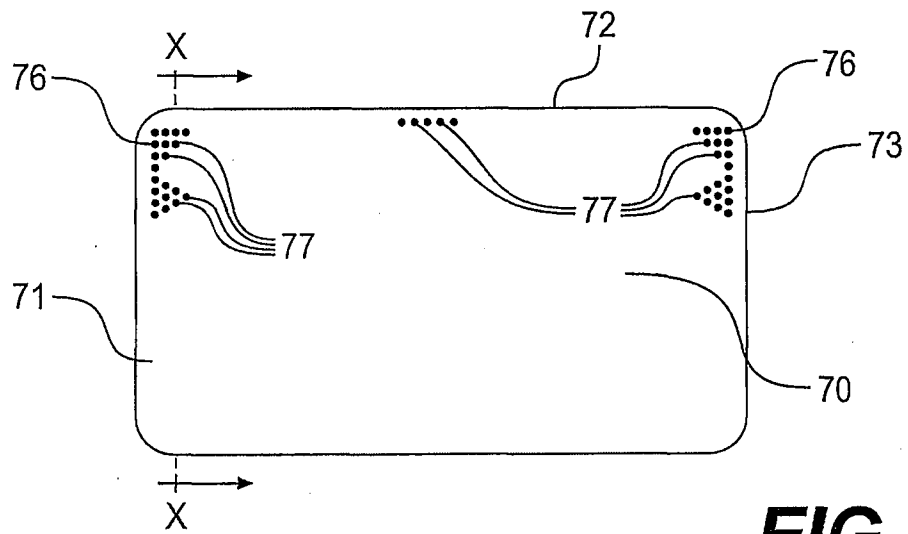


**FIG. 6A**

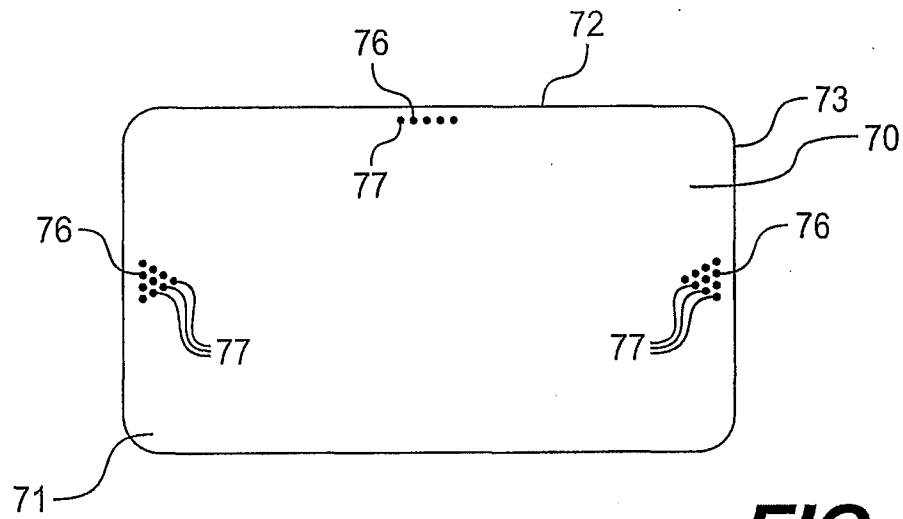


**FIG. 6B**

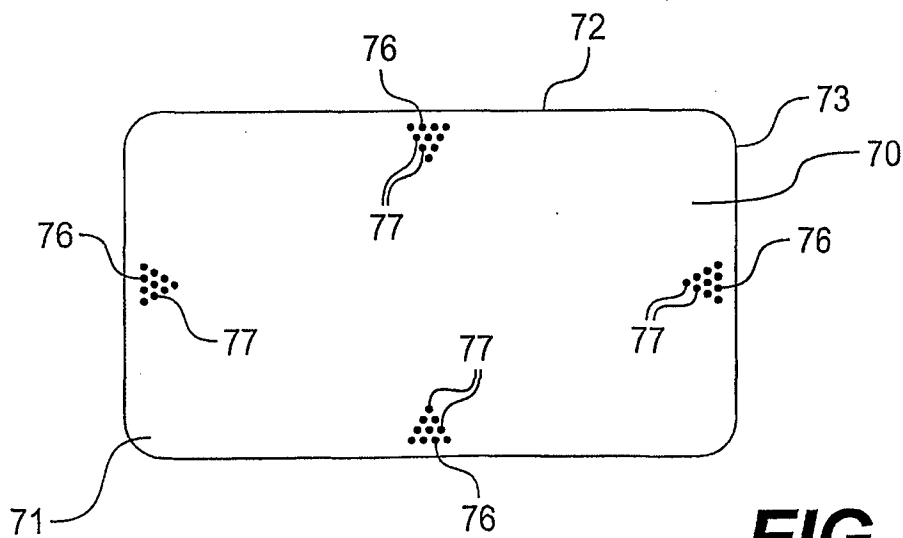
5/10



**FIG. 7A**

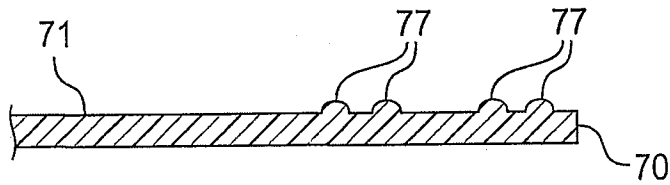


**FIG. 7B**

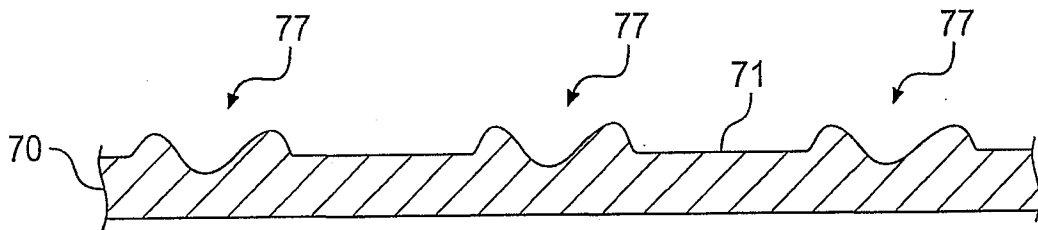


**FIG. 7C**

6/10

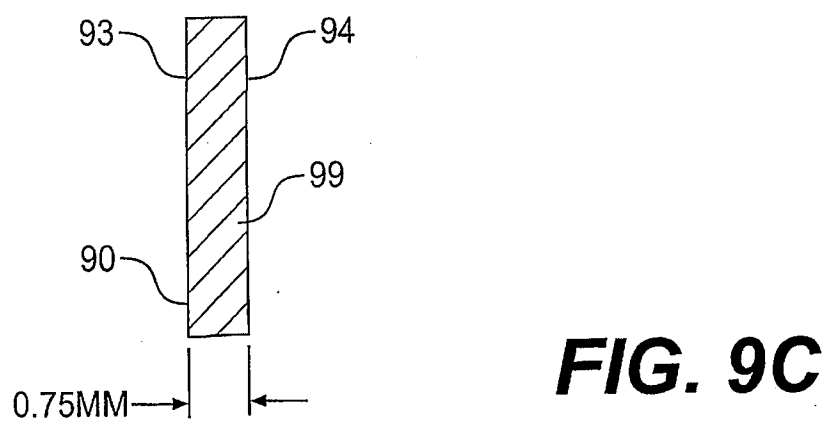
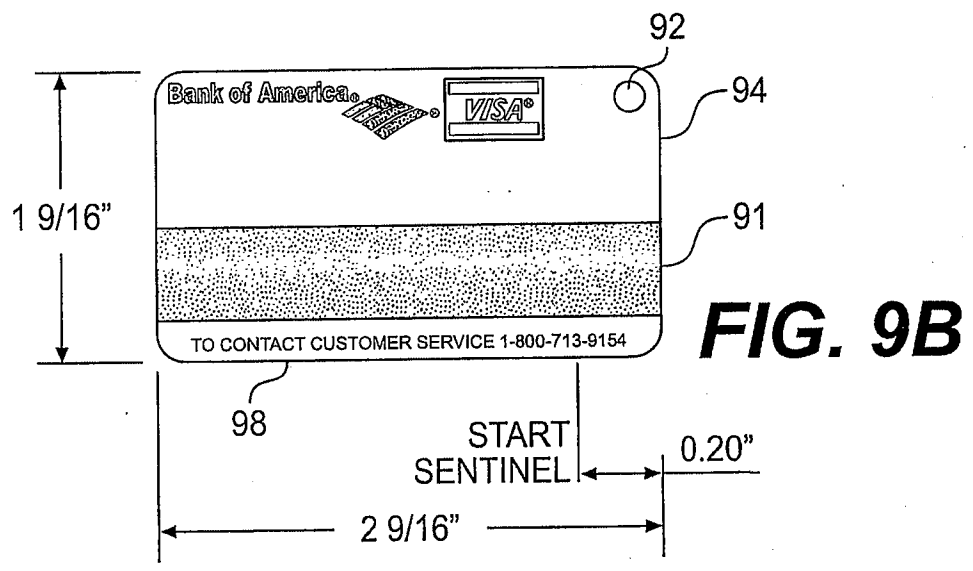
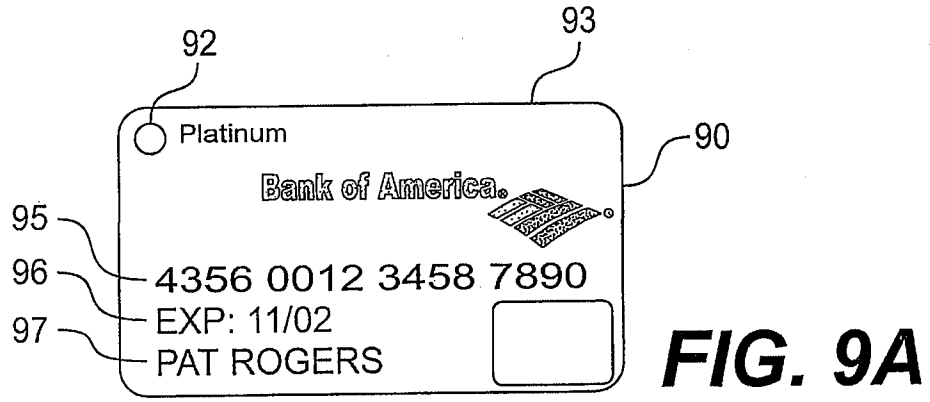


**FIG. 8A**

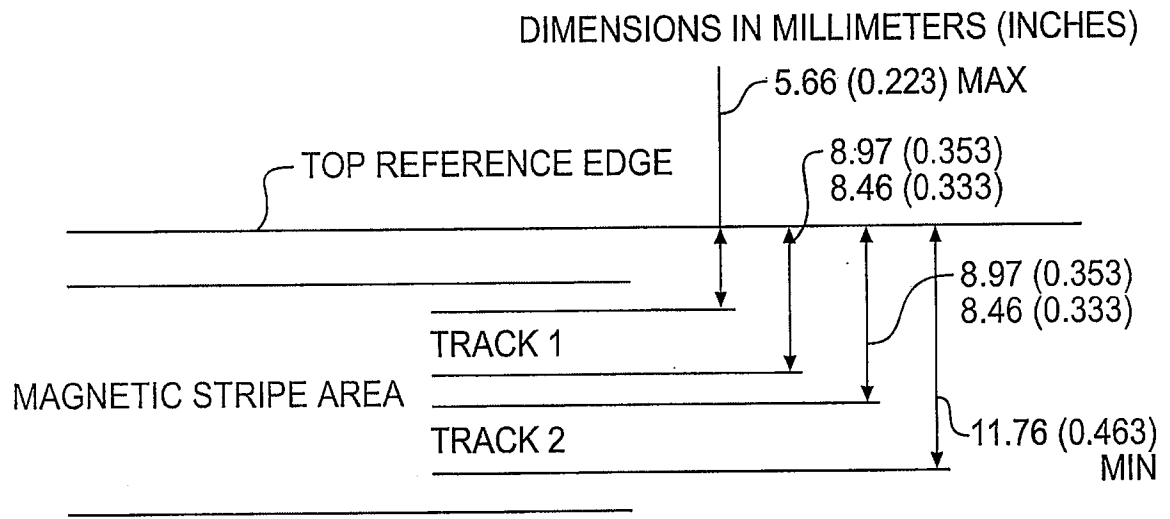


**FIG. 8B**

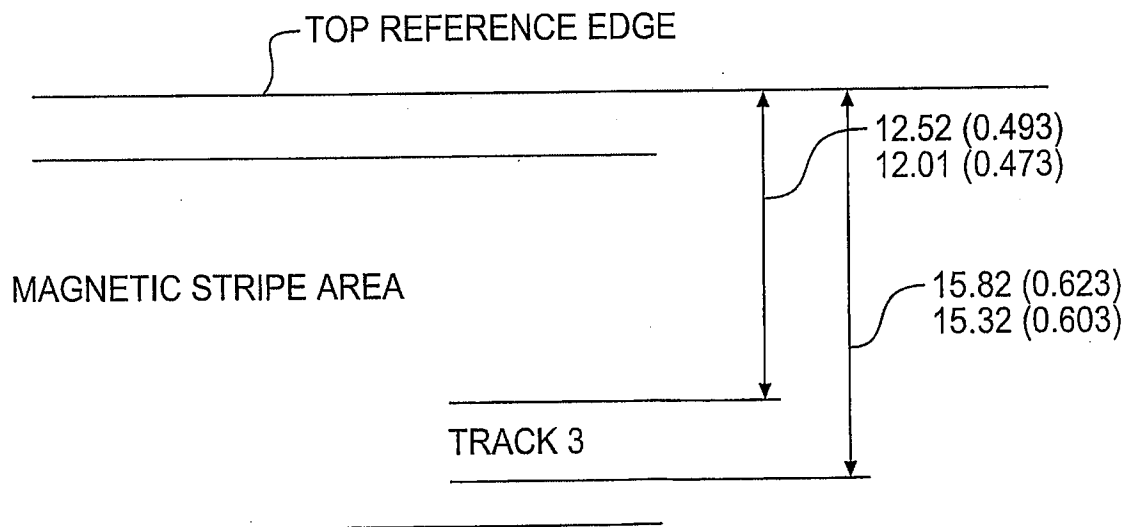
7/10



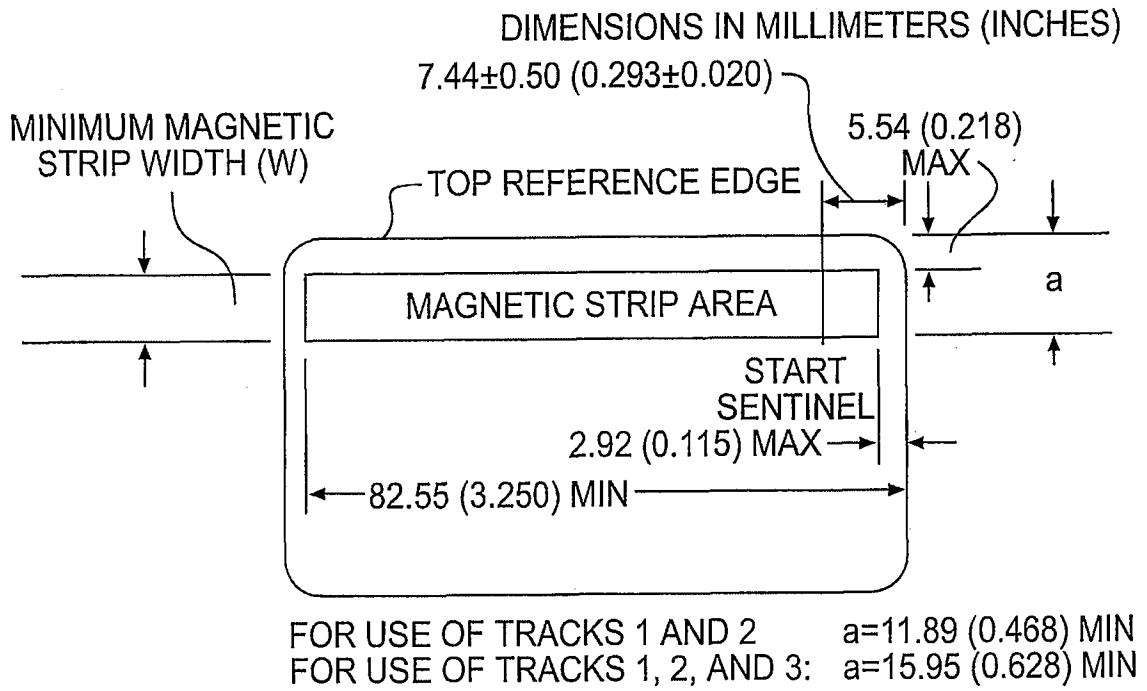
8/10



**FIG. 10**

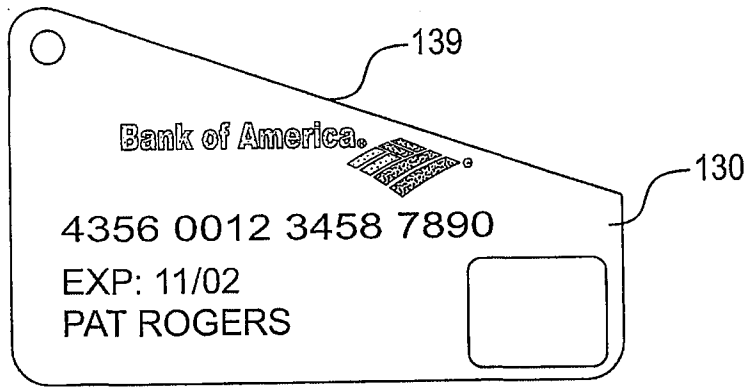


**FIG. 11**

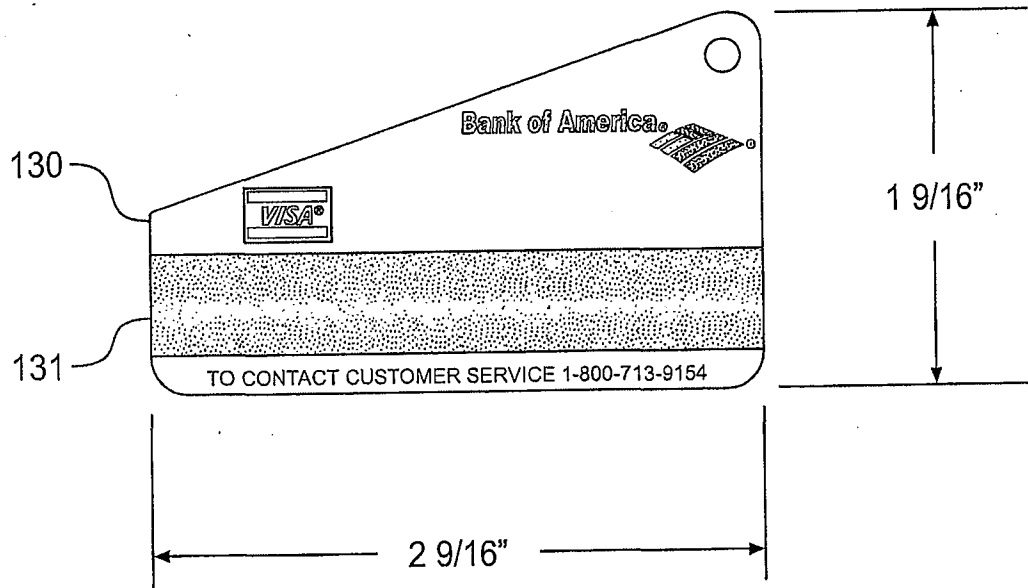


**FIG. 12**

10/10



**FIG. 13A**



**FIG. 13B**

(19) World Intellectual Property Organization  
International Bureau



(43) International Publication Date  
29 August 2002 (29.08.2002)

PCT

(10) International Publication Number  
WO 02/067190 A3

(51) International Patent Classification<sup>7</sup>: G06K 19/04,  
B42D 15/10, G06K 19/00, 7/08, 19/12

Charlotte, NC 28210 (US). KENDLE, A., Allen; 2400  
Valencia Terrace, Charlotte, NC 28210 (US).

(21) International Application Number: PCT/US02/01284

(74) Agent: REISTER, Andrea, G.; Covington & Burling,  
1201 Pennsylvania Avenue, N.W., Washington, DC 20004-  
2401 (US).

(22) International Filing Date: 18 January 2002 (18.01.2002)

(25) Filing Language: English

(81) Designated States (national): AE, AG, AL, AM, AT, AU,  
AZ, BA, BB, BG, BR, BY, BZ, CA, CH, CN, CO, CR, CU,  
CZ, DE, DK, DM, DZ, EC, EE, ES, FI, GB, GD, GE, GH,  
GM, HR, HU, ID, IL, IN, IS, JP, KE, KG, KP, KR, KZ, LC,  
LK, LR, LS, LT, LU, LV, MA, MD, MG, MK, MN, MW,  
MX, MZ, NO, NZ, OM, PH, PL, PT, RO, RU, SD, SE, SG,  
SI, SK, SL, TJ, TM, TN, TR, TT, TZ, UA, UG, UZ, VN,  
YU, ZA, ZM, ZW.

(26) Publication Language: English

(30) Priority Data:  
60/263,756 25 January 2001 (25.01.2001) US  
09/988,151 19 November 2001 (19.11.2001) US

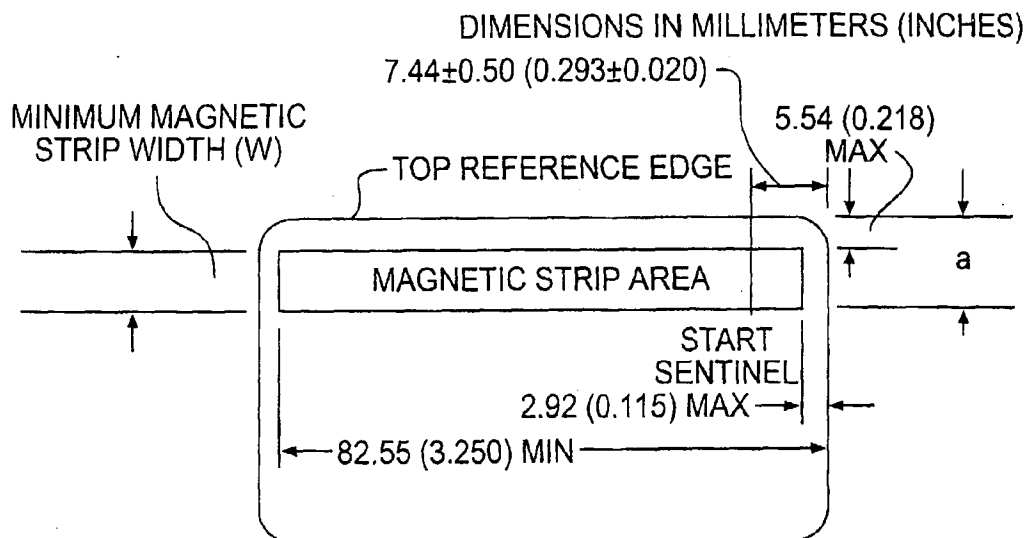
(71) Applicant: BANK OF AMERICA CORPORATION  
[US/US]; NC1-002-29-01, 101 South Tryon Street, Char-  
lotte, NC 28255 (US).

(84) Designated States (regional): ARIPO patent (GH, GM,  
KE, LS, MW, MZ, SD, SL, SZ, TZ, UG, ZM, ZW),  
Eurasian patent (AM, AZ, BY, KG, KZ, MD, RU, TJ, TM),  
European patent (AT, BE, CH, CY, DE, DK, ES, FI, FR,  
GB, GR, IE, IT, LU, MC, NL, PT, SE, TR), OAPI patent  
(BF, BJ, CF, CG, CI, CM, GA, GN, GQ, GW, ML, MR,  
NE, SN, TD, TG).

(72) Inventors: PENTZ, Jamily; 4114 Marquesas Avenue,  
Tega Cay, SC 29708 (US). BURNS, Emmet; 201 N. Tryon  
Street, Charlotte, NC 28255 (US). COLLINS, Richard,  
J.; 148 Whistler Road, Highland Park, IL 60035 (US).  
MONTGOMERY, R., Bruce; 10207 Wildbracken Court,

[Continued on next page]

(54) Title: MINIATURE DATA CARD



FOR USE OF TRACKS 1 AND 2 a=11.89 (0.468) MIN  
FOR USE OF TRACKS 1, 2, AND 3: a=15.95 (0.628) MIN

(57) Abstract: A data card (10) is reduced in size from the conventional standard size credit card. Accessibility of the card is enhanced because the card may be stored in a separate location from conventionally sized cards, such as on a key-chain or similar device. The card of the present invention has a means (17) for storing information, such as a magnetic stripe or computer chip.



WO 02/067190 A3





**Published:**

- with international search report
- before the expiration of the time limit for amending the claims and to be republished in the event of receipt of amendments

*For two-letter codes and other abbreviations, refer to the "Guidance Notes on Codes and Abbreviations" appearing at the beginning of each regular issue of the PCT Gazette.*

**(88) Date of publication of the international search report:**

24 October 2002

## A. CLASSIFICATION OF SUBJECT MATTER

IPC 7 G06K19/04 B42D15/10 G06K19/00 G06K7/08 G06K19/12

According to International Patent Classification (IPC) or to both national classification and IPC

## B. FIELDS SEARCHED

Minimum documentation searched (classification system followed by classification symbols)

IPC 7 G06K B42D

Documentation searched other than minimum documentation to the extent that such documents are included in the fields searched

Electronic data base consulted during the international search (name of data base and, where practical, search terms used)

WPI Data, EPO-Internal, PAJ

## C. DOCUMENTS CONSIDERED TO BE RELEVANT

Category *	Citation of document, with indication, where appropriate, of the relevant passages	Relevant to claim No.
X	RANKL, WOLFGANG: "HANDBUCH DER CHIPKARTEN: AUFBAU, USW." 1999, HANSER VERLAG, MUNICH, VIENNA; ISBN 3-446-21115-2 XP002211214	1-7,9, 11, 13-18, 38-43, 45,47, 49-53, 56,57
Y	page 44 -page 47  page 56 -page 61 page 68 -page 71	6,7,9, 11,12, 19,20, 42,43, 45,47, 48,54,55

 Further documents are listed in the continuation of box C. Patent family members are listed in annex.

## \* Special categories of cited documents:

- \*A\* document defining the general state of the art which is not considered to be of particular relevance
- \*E\* earlier document but published on or after the international filing date
- \*L\* document which may throw doubts on priority claim(s) or which is cited to establish the publication date of another citation or other special reason (as specified)
- \*O\* document referring to an oral disclosure, use, exhibition or other means
- \*P\* document published prior to the international filing date but later than the priority date claimed

- \*T\* later document published after the international filing date or priority date and not in conflict with the application but cited to understand the principle or theory underlying the invention
- \*X\* document of particular relevance; the claimed invention cannot be considered novel or cannot be considered to involve an inventive step when the document is taken alone
- \*Y\* document of particular relevance; the claimed invention cannot be considered to involve an inventive step when the document is combined with one or more other such documents, such combination being obvious to a person skilled in the art.
- \*&\* document member of the same patent family

Date of the actual completion of the international search

28 August 2002

Date of mailing of the international search report

12/09/2002

Name and mailing address of the ISA

European Patent Office, P.B. 5818 Patentlaan 2  
NL - 2280 HV Rijswijk  
Tel. (+31-70) 340-2040, Tx. 31 651 epo nl,  
Fax: (+31-70) 340-3016

Authorized officer

Heusler, N

C.(Continuation) DOCUMENTS CONSIDERED TO BE RELEVANT		
Category *	Citation of document, with indication, where appropriate, of the relevant passages	Relevant to claim No.
X	DE 199 01 965 A (GIESECKE & DEVRIENT GMBH) 20 July 2000 (2000-07-20)	1, 2, 12, 18, 38, 48, 53
Y	column 1, line 22 - line 37	5-7, 9, 11, 12, 19-21, 42, 43, 45, 47, 48, 54-56
	column 2, line 33 - line 35; figure 1	
X	EP 0 495 216 A (ORGA KARTENSYSTEME GMBH) 22 July 1992 (1992-07-22)	1-5, 13, 17, 18, 21, 22, 29, 31, 33
Y	the whole document	23, 24, 26, 28, 34, 35
X	WO 01 01324 A (MICHELSEN CHRISTIAN ;IP TPG HOLDCO SARL (LU)) 4 January 2001 (2001-01-04) figure 1	1, 38
Y	US 5 298 897 A (HARRISON CLARENCE ET AL) 29 March 1994 (1994-03-29)	6, 7, 9, 11, 23, 24, 26, 28, 42, 43, 45, 47
	column 1, line 16 - line 22 column 7, line 28 - line 46	
Y	DE 298 02 638 U (POHL THOMAS) 10 June 1998 (1998-06-10) the whole document	12, 36, 48
Y	DE 298 12 046 U (BUERGER ROLF) 26 November 1998 (1998-11-26)	12, 19, 20, 34-36, 48, 54, 55
	claims 2-4; figures 1, 2	
Y	WO 99 34323 A (BANK OF AMERICA) 8 July 1999 (1999-07-08)	19, 20, 34, 35, 54, 55
	claims 1, 6-9	
Y	EP 0 933 718 A (STAR MFG CO) 4 August 1999 (1999-08-04)	7-10, 24-27, 43-46
	paragraphs '0009!', '0024!	
	-/--	

## C.(Continuation) DOCUMENTS CONSIDERED TO BE RELEVANT

Category °	Citation of document, with indication, where appropriate, of the relevant passages	Relevant to claim No.
Y	US 5 204 513 A (STEELE GEORGE R) 20 April 1993 (1993-04-20)  column 2, line 1,42,43 ---	7-10, 24-27, 43-46
Y	US 4 857 945 A (FAES STEVEN M) 15 August 1989 (1989-08-15) column 19, line 28; figure 2 ---	5,21,56
Y	US 5 461 219 A (CRONVALL LEIF) 24 October 1995 (1995-10-24) column 7, line 4 - line 8; figure 1 ---	5,21,56
A	PATENT ABSTRACTS OF JAPAN vol. 2000, no. 07, 29 September 2000 (2000-09-29) & JP 2000 113136 A (ADAMUSU: KK), 21 April 2000 (2000-04-21) abstract ---	12,36,48
E	US 2002/092914 A1 (COLLINS RICHARD J ET AL) 18 July 2002 (2002-07-18)	1-57
X	paragraphs '0075!', '0076!  -----	8,10,25, 27,44,46

Patent document cited in search report	Publication date	Patent family member(s)	Publication date
DE 19901965	A	20-07-2000	DE 19901965 A1 20-07-2000 AU 2438300 A 07-08-2000 BR 0007549 A 04-12-2001 CN 1338083 T 27-02-2002 WO 0043950 A1 27-07-2000 EP 1151411 A1 07-11-2001
EP 0495216	A	22-07-1992	DE 4040296 C1 09-01-1992 AT 145077 T 15-11-1996 DE 59108328 D1 12-12-1996 EP 0495216 A2 22-07-1992 ES 2094184 T3 16-01-1997
WO 0101324	A	04-01-2001	AU 5813100 A 31-01-2001 WO 0101324 A1 04-01-2001
US 5298897	A	29-03-1994	US 5168275 A 01-12-1992 US 5379037 A 03-01-1995 BR 9100514 A 29-10-1991 CA 2032414 C 12-09-1995 CA 2032414 A1 08-08-1991 EP 0441280 A1 14-08-1991 JP 2584132 B2 19-02-1997 JP 4348488 A 03-12-1992 JP 2846847 B2 13-01-1999 JP 8273306 A 18-10-1996 JP 2915334 B2 05-07-1999 JP 8255211 A 01-10-1996
DE 29802638	U	10-06-1998	DE 29802638 U1 10-06-1998
DE 29812046	U	26-11-1998	DE 29812046 U1 26-11-1998
WO 9934323	A	08-07-1999	AU 2209099 A 19-07-1999 WO 9934323 A1 08-07-1999
EP 0933718	A	04-08-1999	JP 11219507 A 10-08-1999 EP 0933718 A2 04-08-1999
US 5204513	A	20-04-1993	NONE
US 4857945	A	15-08-1989	AU 621545 B2 19-03-1992 AU 1943888 A 06-12-1988 EP 0360828 A1 04-04-1990 JP 2504013 T 22-11-1990 NO 890162 A 09-03-1989 NZ 224651 A 26-05-1992 NZ 236481 A 26-05-1992 WO 8808962 A1 17-11-1988
US 5461219	A	24-10-1995	SE 466323 B 27-01-1992 AU 9109591 A 22-07-1992 DE 69120966 D1 22-08-1996 DE 69120966 T2 17-04-1997 EP 0563136 A1 06-10-1993 SE 9004054 A 27-01-1992 WO 9211613 A1 09-07-1992

Patent document cited in search report	Publication date	Patent family member(s)	Publication date
JP 2000113136	A	NONE	
US 2002092914	A1	AU 8639001 A WO 0204227 A1	21-01-2002 17-01-2002